



PORTABLE DAVIT CRANE

# Rescue Rated Series



*Product Shown:*  
5PT20R-M2R



thern.com  
(507) 454-2996

# RESCUE RATED

## PORTABLE DAVIT CRANE

### HEAVY LIFTING POWER with Enhanced Flexibility and Portability

Retaining all the same quality and material handling benefits as the original Commander Series, Thern's 5PT10 and 5PT20 are now available in new configurations that extend their superior performance to the personnel rescue arena. Thern Rescue Rated Davits are preconfigured with a manually operated worm gear hand winch, 1/4" wire rope, and an anchorage connector that are all compliant with ANSI / OSHA standards and can be used as part of a complete one or two person rescue system to rescue individuals from land and water or provide rescue to persons trapped in confined spaces (shafts, tanks, exhaust stacks, etc.) Rescue configurations come with multiple base options to meet a variety of mounting needs. Stainless-steel cranes and bases are also available for the most corrosive environments.

Product Shown:  
5PT20R-M2R

### Enhanced Portability

- Disassembles and reassembles easily, using quick-release hardware and pins for quick transport to storage or bases at other work sites—no tools required
- Perfect for applications that require material handling and also require a rescue plan for personnel working in the area. These cranes provide robust capabilities for the most demanding loads and can also be quickly deployed should the unthinkable occur and a team member requires lifesaving assistance

### 360° Rotation & Flexible Operation

- Heavy-duty Nylatron® bushing at base enhances smooth, 360-degree rotation under load for precise load placement. Optional rotation bearing and lock ease movement and stabilize unloading
- Innovative rotation handle design does not interfere with boom angle adjustment for easier operation
- Telescoping boom and adjustable boom angles allow for precise reach and height positioning



## STANDARD CONFIGURATIONS

### IMPERIAL/METRIC

Series	Description	Rescue Capacity	Material Capacity
5PT10R-M2R	Powder-coat crane with 4WM2R-K worm gear hand winch	310 lbs / 141 kg	1,200 lbs / 540 kg
5PT10RS-M2R	Stainless Steel crane with 4WM2R-K worm gear hand winch	310 lbs / 141 kg	1,200 lbs / 540 kg
5PT10RS-M2RX	Stainless Steel crane with epoxy 4WM2R-K worm gear hand winch	310 lbs / 141 kg	1,200 lbs / 540 kg
5PT20R-M2R	Powder-coat crane with 4WM2R-K worm gear hand winch	620 lbs / 282 kg	2,000 lbs / 905 kg
5PT20RS-M2R	Stainless Steel crane with 4WM2R-K worm gear hand winch	620 lbs / 282 kg	2,000 lbs / 905 kg
5PT20RS-M2RX	Stainless Steel crane with epoxy 4WM2R-K worm gear hand winch	620 lbs / 282 kg	2,000 lbs / 905 kg

#### Durable Construction & Finish

- Heavy-duty, welded structural steel pipe and tubing limit deflection and meet/exceed ASTM standards
- Corrosion-resistant, powder-coated frame, mast cap, and stainless-steel fasteners resist the elements for long service life
- 304 stainless-steel finishes are available for corrosive environments

#### Flexible Configurations

- A variety of base mounting options, including pedestal, flush, and wall-mount help meet unique lifting needs
- A quick-mount winch bracket is standard (no tools required) and accommodates the Thern 4WM2R-K worm gear hand winch



NOTICE: For rescue use only. Not to be used as a personnel rated crane or as a fall arrest system.

Refer to technical pages for detailed performance information.

# TECHNICAL DRAWINGS & SPECIFICATIONS

# RESCUE RATED PORTABLE DAVIT CRANE

## CONFIGURATIONS

Model	Description	Approx. Ship Wt.	
		(lb)	(kg)
<b>Available Configurations</b>			
5PT10R-M2R	up to a 1,200 lbs capacity with 4WM2R-K worm gear hand winch – powder-coat crane	164	74
5PT10RS-M2R	up to a 1,200 lbs capacity with 4WM2R-K worm gear hand winch – stainless steel crane	164	74
5PT10RS-M2RX	up to a 1,200 lbs capacity with epoxy 4WM2R-K worm gear hand winch – stainless steel crane	164	74
5PT20R-M2R	up to 2,000 lb capacity with 4WM2R-K worm gear hand winch – powder-coat crane	255	166
5PT20RS-M2R	up to 2,000 lb capacity with 4WM2R-K worm gear hand winch – stainless steel crane	255	166
5PT20RS-M2RX	up to a 2,000 lbs capacity with epoxy 4WM2R-K worm gear hand winch – stainless steel crane	255	166

### Independent Bases—sold separately

**Pedestal, socket, or wall-mount style.**

**Wheel bases are NOT** used for the Rescue Rated Davit Cranes.

**IMPORTANT:** Base installation is the customer's responsibility. Thern recommends consulting a civil engineer or other qualified professional. Contact Thern for installation guidelines.

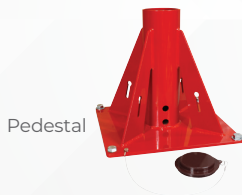

Pedestal



Flush



Wall Mount

Finish	Pedestal	Flush	Wall
Powder Coat Paint	5BP10	5BF10	5BW10
	5BP20	5BF20	5BW20
304 Stainless Steel	5BP10S	5BF10S	5BW10S
	5BP20S	5BF20S	5BW20S
Approximate Ship Weight	66 lbs (30 kg)	57 lbs (26 kg)	64 lbs (30 kg)

### Wire Rope Assemblies

**Galvanized** wire rope assemblies with swaged-ball fitting to work with the quick-disconnect anchor on the winch. Please contact Thern for additional information.

**Note:** Thern Rescue Rated Davit systems were designed, tested, and rated using this specific wire rope assembly. Other types of wire rope or assemblies may not meet required specifications.

Wire Rope Length		Galvanized Aircraft Cable		
		1/4" Dia. (6.4 mm)	Approx. Ship Weight	
(ft)	(m)	Model No.	(lbs)	(kg)
60	18.2	WA25-60NT	9 lbs	4 kg

## PERFORMANCE

### Rescue Rated Commander Series Lift Below Floor<sup>2</sup> Level

Lift Below Floor <sup>1</sup>		Wire Rope Diameter		Wire Rope Length <sup>3</sup>		Winch Configuration Maximum Winch Rating			
SPT10R									
Minimum (C4)		Maximum (C1)				M2R			
(ft)	(m)	(ft)	(m)	(in)	(mm)	(ft)	(m)	(lbs)	(kg)
2	0.6	7	2.1	1/4"	6	20	6.0	1,200	545
10	3.0	15	4.5	1/4"	6	28	8.5	1,200	545
18	5.4	23	7.0	1/4"	6	36	10.9	1,200	545
27	8.2	32	9.7	1/4"	6	45	13.7	1,200	545
42	12.8	47	14.3	1/4"	6	60	18.2	1,200	545
SPT20R									
0	0.0	5	1.5	1/4"	6	20	6.0	2,000	905
8	2.4	13	3.9	1/4"	6	28	8.5	1,700	770
16	4.8	21	6.4	1/4"	6	36	10.9	1,700	770
25	7.6	30	9.1	1/4"	6	45	13.7	1,500	680
40	12.1	45	13.7	1/4"	6	60	18.2	1,300	590

<sup>1</sup>Lift below floor level varies depending on boom position and base configuration. For longer lifts, please contact factory.

<sup>2</sup>Performance characteristics are for standard products referred to in this manual. Non-standard products may vary from the original design. Contact Thern, Inc. for this information.

<sup>3</sup>Wire rope assemblies include a hook and a swaged-ball fitting to work with quick-disconnect anchor on winches, and 316SS wire rope is also available. Please contact the factory.

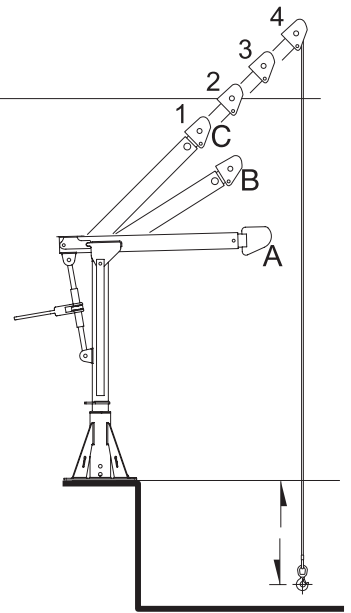

Lift Below Floor Level

### Commander 1000 Performance Ratings<sup>2</sup>

	Boom Position	Load Rating		Rescue Rated	
		(lb)	(kg)	(lb)	(kg)
BLUE RANGE	A-1	1,000	455	310	144
	A-2	800	360	-	-
	A-3	650	295	-	-
	A-4	550	250	-	-
GREEN RANGE	B-1	1,200	545	310	144
	B-2	950	430	310	144
	B-3	750	340	-	-
	B-4	650	295	-	-
	C-1	1,200	545	310	144
	C-2	950	430	310	144
	C-3	750	340	-	-
	C-4	650	295	-	-

### Commander 1000 Performance Ratings<sup>2</sup>

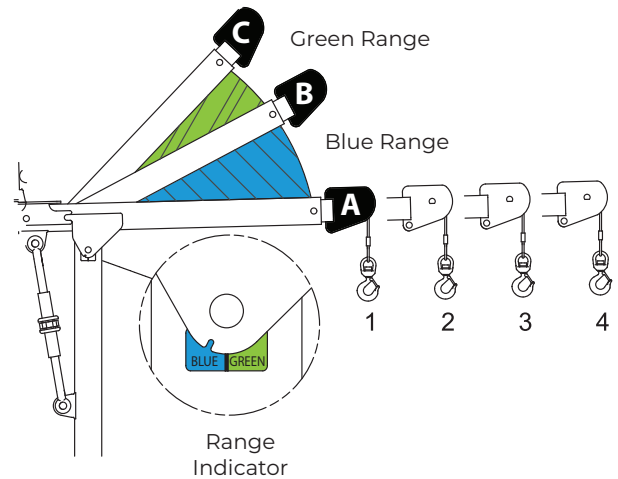

### Commander 2000 Performance Ratings<sup>2</sup>

	Boom Position	Load Rating		Rescue Rated	
		(lb)	(kg)	(lb)	(kg)
BLUE RANGE	A-1	2,000	905	620	282
	A-2	1,600	725	-	-
	A-3	1,300	590	-	-
	A-4	1,100	500	-	-
GREEN RANGE	B-1	2,000	905	620	282
	B-2	1,900	860	620	282
	B-3	1,500	680	-	-
	B-4	1,300	590	-	-
	C-1	2,000	905	620	282
	C-2	1,900	860	620	282
	C-3	1,500	680	-	-
	C-4	1,300	590	-	-

### Commander 2000 Performance Ratings<sup>2</sup>

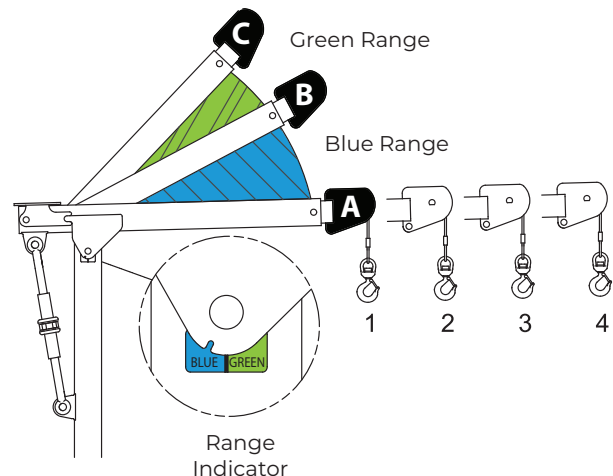

## Rescue Rated Series with Pedestal Base Reach & Height Above Floor<sup>1</sup>

Boom Position	Hook Reach		Hook Height	
<b>5PT10</b>				
	(in)	(mm)	(in)	(mm)
A-1	36	914	42	1,066
A-2	46	1,168	42	1,066
A-3	56	1,422	42	1,066
A-4	66	1,676	42	1,066
B-1	29	736	56	1,422
B-2	38	965	60	1,524
B-3	47	1,193	65	1,651
B-4	56	1,422	69	1,752
C-1	22	558	64	1,625
C-2	29	736	71	1,803
C-3	36	914	78	1,981
C-4	43	1,092	85	2,159

<b>5PT20</b>				
	(in)	(mm)	(in)	(mm)
A-1	46	1,168	43	1,092
A-2	58	1,473	43	1,092
A-3	70	1,778	43	1,092
A-4	82	2,082	43	1,092
B-1	37	939	61	1,549
B-2	48	1,219	67	1,701
B-3	58	1,473	72	1,828
B-4	69	1,752	78	1,981
C-1	28	711	71	1,803
C-2	36	914	80	2,032
C-3	45	1,143	88	2,235
C-4	53	1,346	97	2,463

<sup>1</sup> Performance characteristics are for standard products. Non-standard products may vary from the original design. Contact Thern, Inc. for this information.

Dimensions are for reference only and subject to change without notice.

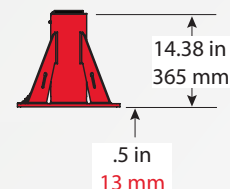
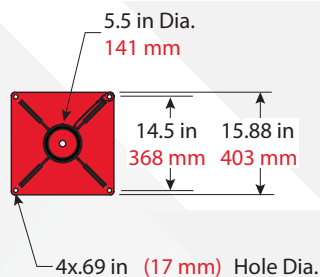

### Rescue Rated Compatible Pedestal Base

5BP10      5BP10S  
5BP20      5BP20S

## Rescue Rated Series with Flush- or Wall-Mount Base Reach & Height Above Floor<sup>1</sup>

Boom Position	Hook Reach		Hook Height	
<b>5PT10</b>				
	(in)	(mm)	(in)	(mm)
A-1	36	914	28	711
A-2	46	1,168	28	711
A-3	56	1,422	28	711
A-4	66	1,676	28	711
B-1	29	736	42	1,066
B-2	38	965	46	1,168
B-3	47	1,193	51	1,295
B-4	56	1,422	55	1,397
C-1	22	558	50	1,270
C-2	29	736	57	1,447
C-3	36	914	64	1,625
C-4	43	1,092	71	1,803

<b>5PT20</b>				
	(in)	(mm)	(in)	(mm)
A-1	46	1,168	29	736
A-2	58	1,473	29	736
A-3	70	1,778	29	736
A-4	82	2,082	29	736
B-1	37	939	47	1,193
B-2	48	1,219	53	1,346
B-3	58	1,473	58	1,473
B-4	69	1,752	64	1,625
C-1	28	711	57	1,447
C-2	36	914	66	1,676
C-3	45	1,143	74	1,879
C-4	53	1,346	83	2,108

<sup>1</sup> Performance characteristics are for standard products. Non-standard products may vary from the original design. Contact Thern, Inc. for this information.

Dimensions are for reference only and subject to change without notice.

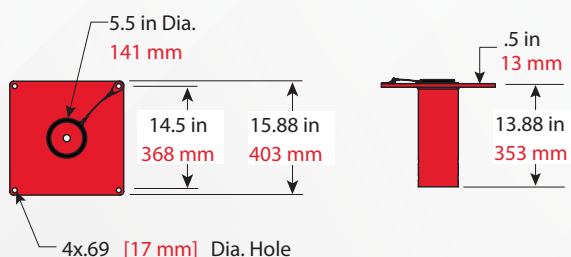

### Rescue Rated Compatible Flush-Mount Base

5BF10      5BF10S      5BF20      5BF20S

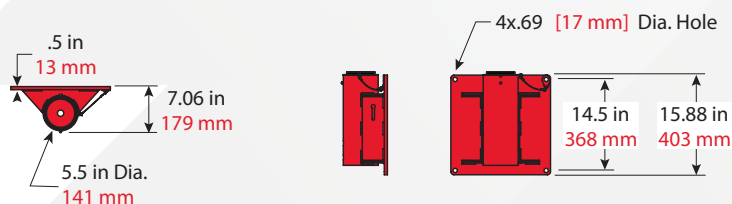

### Rescue Rated Compatible Wall-Mount Base

5BW10      5BW10S      5BW20      5BW20S

# RESCUE RATED

## ACCESSORIES

Already have a Thern 5PT10-M2 or 5PT20-M2 that you would like to convert to a Rescue Rated Configuration? Thern Rescue Rated Conversion kits are available that contain the correct wire rope assembly, labels, and supplemental instructions required to give your Thern Davit crane rescue capabilities.



### Rescue Rated Kit

5PT10R-M2R-KIT

5PT20R-M2R-KIT

Comes with the following items:

- WA25-60NT – Sixty Feet of ¼" Galvanized Aircraft Cable. One end finished with a swaged ball, and the other with a thimble. **Note: Thern Rescue Rated Davit systems were designed, tested, and rated using this specific wire rope assembly. Other types of wire rope or assemblies may not meet required specifications.**
- ANSI Rated Carabiner – Triple lock gate, 40kN, carbon steel carabiner rated to ANZI Z359.12.
- Rescue Rated Labels – All equipment labels as required by Thern's Rescue Rated design intent and applicable standards.
- Supplemental Rescue Rated Instructions – Additional information related to the rescue rated configuration, its capabilities, restrictions, and important safety notes. Also outlines labeling, inspection, and personnel training requirements per ANSI standards.

**NOTE: Rescue Rated Conversion Kits currently not available for model numbers other than the 5PT10-M2 and 5PT20-M2 (steel or stainless steel versions).**



**MADE IN USA** 

**Thern, Incorporated**

World Headquarters  
5712 Industrial Park Road Winona, MN USA  
Toll Free: 1-800-843-7648  
Phone: 1-507-454-2996  
[www.thern.com](http://www.thern.com)

**Thern Europe**

Siriusdreef 17-27, 2132 WT  
The Netherlands  
Phone: +31-546-898-380  
[europe@thern.com](mailto:europe@thern.com)